

Catalogue 2026

Root canal treatment solutions

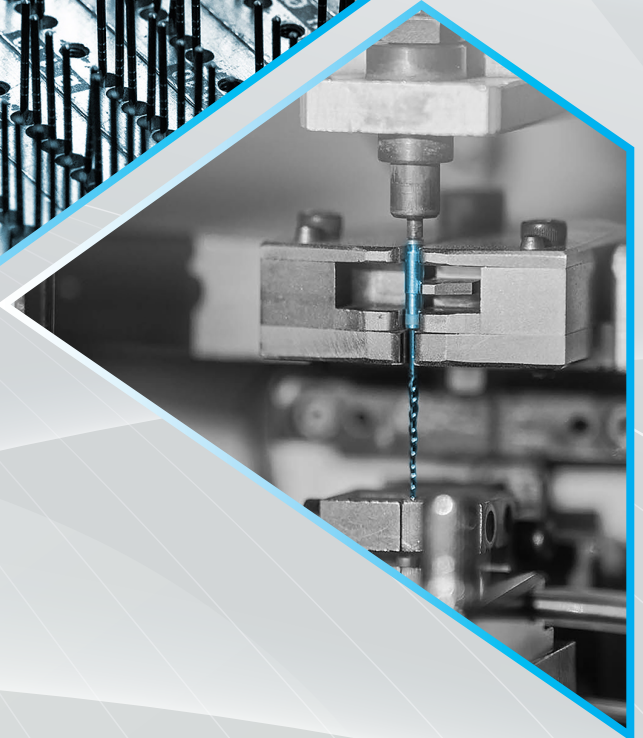
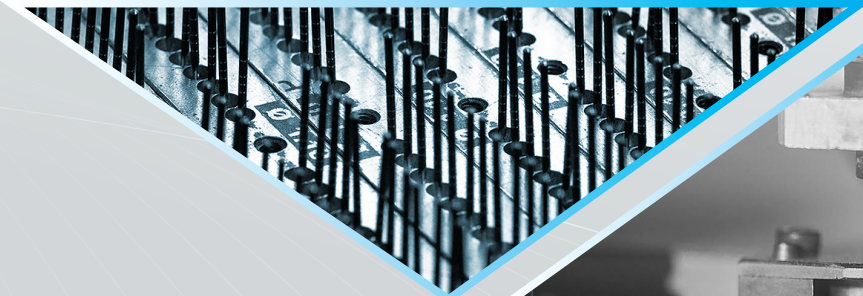
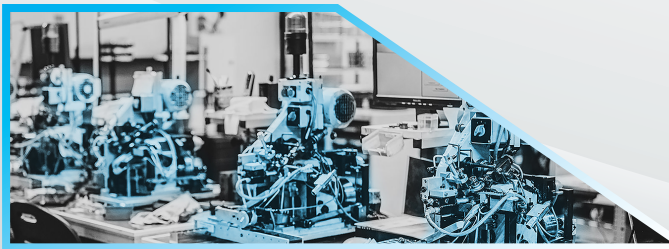

Micro-Mega...

Since its foundation in 1905, Micro-Mega has established itself as a key player in the world of dental health, combining tradition and innovation. With a history rich in know-how and technical excellence, Micro-Mega excels in the design and manufacture of state-of-the-art instruments and solutions. By joining the Swiss Coltene Group in 2018, the company has strengthened its commitment to offering high-tech products tailored to the demands of modern practitioners.

In 2025, we celebrated 120 years of excellence, a key milestone that marks our continued commitment to push the boundaries of performance and quality for dental professionals.

Micro-Mega continually invests in research and development to anticipate the needs of the dental sector, with unrivalled expertise in creating innovative, high-performance solutions. Every stage of the production process, from design to delivery, is carried out in-house, guaranteeing total control and optimum traceability.

For over a century, Micro-Mega has been innovating to offer instruments and materials of exceptional precision, meeting the highest quality standards. From rotary instruments and restorative materials to hygiene and endodontics products, our comprehensive range is designed for all dental specialties, ensuring safety and comfort for practitioners and patients alike.

All our products are designed to the highest international standards and are ISO-certified and CE-compliant, guaranteeing reliability, durability and safety.



Contents

HandFiles

4

HandFiles

Classics

- K-Files
- H-Files
- K-Reamers

Twisted technology

- MM K-Files
- MM H-Files

Primeline

- MM K-Files
- MM H-files

Nerves Broaches



Mechanized files

12

One Flare

One G

One Glider & RECI Glider

2Shape classic & mini

One Curve classic & mini

MM TAPER

One RECI

HERO 642

HERO Shaper

Revo Condensor

REMOVER



Motor

28

MM 4000



Irrigation Obturation

30

CanalPro NaOCl 3%

CanalPro NaOCl 6%

MicroMega MM-MTA

MicroMega MM-SEAL

MicroMega MM-PASTE

MM Bioceramic Putty

MM Bioceramic Sealer



MANUAL SECURING

MicroMega HandFiles



Diameters

006 to 140



Taper

2%



Lengths

21mm

25mm

31mm



- Precision-crafted handfiles for manually scouting or shaping root canals
- Provided in sterile blister

K-Files



Blister of 6 pre-sterilized instruments, multiple use

Length	006	008	010	015	020	025	030	035	040	045	050
L21	60029717	60029720	60029723	60029726	60029729	60029732	60029735	60029738	60029741	60029744	60029747
L25	60029718	60029721	60029724	60029727	60029730	60029733	60029736	60029739	60029742	60029745	60029748
L31	60029719	60029722	60029725	60029728	60029731	60029734	60029737	60029740	60029743	60029746	60029749

Length	055	060	070	080	090	100	110	120	130	140
L21	60029750	60029753	60029756	60029759	60029762	60029765	60029768	60029771	60029774	60029777
L25	60029751	60029754	60029757	60029760	60029763	60029766	60029769	60029772	60029775	60029778
L31	60029752	60029755	60029758	60029761	60029764	60029767	60029770	60029773	60029776	60029779

Length	008/015	015/040
L25	60029992	60029841
L31	-	60029842

H-Files



Blister of 6 pre-sterilized instruments, multiple use

Length	008	010	015	020	025	030	035	040	045	050	055
L21	60029780	60029783	60029786	60029789	60029792	60029795	60029798	60029801	60029804	60029807	60029810
L25	60029781	60029784	60029787	60029790	60029793	60029796	60029799	60029802	60029805	60029808	60029811
L31	60029782	60029785	60029788	60029791	60029794	60029797	60029800	60029803	60029806	60029809	60029812

Length	060	070	080	090	100	110	120	130	140
L21	60029813	60029816	60029819	60029822	60029825	60029828	60029831	60029834	60029837
L25	60029814	60029817	60029820	60029823	60029826	60029829	60029832	60029835	60029838
L31	60029815	60029818	60029821	60029824	60029827	60029830	60029833	60029836	60029839

Length	008/015	015/040
L25	60029995	60029844
L31	-	60029845

K-Reamers



Blister of 6 pre-sterilized instruments, multiple use

Length	006	008	010	015	020	025	030	035	040	045	050
L21	60029654	60029657	60029660	60029663	60029666	60029669	60029672	60029675	60029678	60029681	60029684
L25	60029655	60029658	60029661	60029664	60029667	60029670	60029673	60029676	60029679	60029682	60029685
L31	60029656	60029659	60029662	60029665	60029668	60029671	60029674	60029677	60029680	60029683	60029686

Length	055	060	070	080	090	100	110	120	130	140
L21	60029687	60029690	60029693	60029696	60029699	60029702	60029705	60029708	60029711	60029714
L25	60029688	60029691	60029694	60029697	60029700	60029703	60029706	60029709	60029712	60029715
L31	60029689	60029692	60029695	60029698	60029701	60029704	60029707	60029710	60029713	60029716

Length	015/040
L25	60029847
L31	60029848

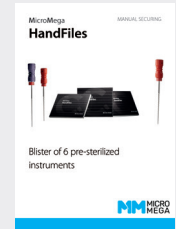

Flyer Micro-Mega HandFiles

EN	FR
80000152	80000151

MANUAL SECURING

MicroMega MM HandFiles



- Twisted-crafted handfiles for manual scouting or shaping root canals
- Cost-saving
- Provided in non sterile pack



NEW

MM K-Files

Non-sterile pack of 6 instruments, multiple use
Twisted-crafted K-Files

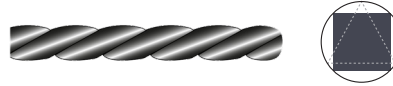

Diameters

006 to 080



Taper

2%



Lengths

21mm 25mm 31mm

Length	006	008	010	015	020	025	030	035	040	045	050
L21	60040665	60040666	60040667	60040668	60040669	60040670	60040671	60040672	60040673	60040674	60040675
L25	60040682	60040683	60040684	60040685	60040686	60040687	60040688	60040689	60040690	60040691	60040692
L31	60040701	60040702	60040703	60040704	60040705	60040706	60040707	60040708	60040709	60040710	60040711

Length	055	060	070	080	008/030	015/040	035/060	045/080
L21	60040676	60040677	60040678	60040679	/	60040680	/	60040681
L25	60040693	60040694	60040695	60040696	60040699	60040697	60040700	60040698
L31	60040712	60040713	60040714	60040715	/	60040716	/	60040717

MM H-Files

Non-sterile pack of 6 instruments, multiple use

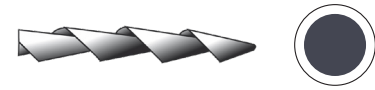

Diameters

008 to 080



Taper

2%



Lengths

21mm 25mm 31mm

Length	008	010	015	020	025	030	035	040	045	050	055
L21	60040788	60040789	60040790	60040791	60040792	60040793	60040794	60040795	60040796	60040797	60040798
L25	60040804	60040805	60040806	60040807	60040808	60040809	60040810	60040811	60040812	60040813	60040814
L31	60040821	60040822	60040823	60040824	60040825	60040826	60040827	60040828	60040829	60040830	60040831

Length	060	070	080	008/015	015/040	045/080
L21	60040799	60040800	60040801	/	60040802	60040803
L25	60040815	60040816	60040817	60040818	60040819	60040820
L31	60040832	60040833	60040834	/	60040835	60040836

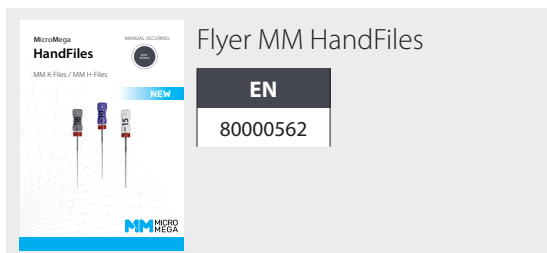

MANUAL SECURING

MicroMega MM HandFiles

PrimeLine



To BE DISCONTINUED
31.12.2026

MM K-Files

Non-sterile pack of 6 instruments, multiple use

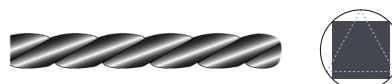

Diameters

006 to 080



Taper

2%



Lengths

21mm

25mm

29mm

Length		006	008	010	015	020	025	030	035	040
L21	PrimeLine	20102001L	20102004L	20102007L	20102010L	20102013L	20102016L	20102019L	20102022L	20102025L
	New Ref.	60040665	60040666	60040667	60040668	60040669	60040670	60040671	60040672	60040673
L25	PrimeLine	20102002L	20102005L	20102008L	20102011L	20102014L	20102017L	20102020L	20102023L	20102026L
	New Ref.	60040682	60040683	60040684	60040685	60040686	60040687	60040688	60040689	60040690
L29	PrimeLine	20102003L	20102006L	20102009L	20102012L	20102015L	20102018L	20102021L	20102024L	20102027L
	New Ref.	60040701	60040702	60040703	60040704	60040705	60040706	60040707	60040708	60040709

Length		045	050	055	060	070	080
L21	PrimeLine	20102028L	20102031L	20102034L	20102037L	20102040L	20102043L
	New Ref.	60040674	60040675	60040676	60040677	60040678	60040679
L25	PrimeLine	20102029L	20102032L	20102035L	20102038L	20102041L	20102044L
	New Ref.	60040691	60040692	60040693	60040694	60040695	60040696
L29	PrimeLine	20102030L	20102033L	20102036L	20102039L	20102042L	20102045L
	New Ref.	60040710	60040711	60040712	60040713	60040714	60040715

Length		008/030	015/040	035/060	045/080
L21	PrimeLine	/	20102064L	/	20102067L
	New Ref.	/	60040680	/	60040681
L25	PrimeLine	20102121L	20102065L	20102122L	20102068L
	New Ref.	60040699	60040697	60040700	60040698
L31	PrimeLine	/	20102066L		20102069L
	New Ref.	/	60040716		60040717

MM H-Files

Non-sterile pack of 6 instruments, multiple use

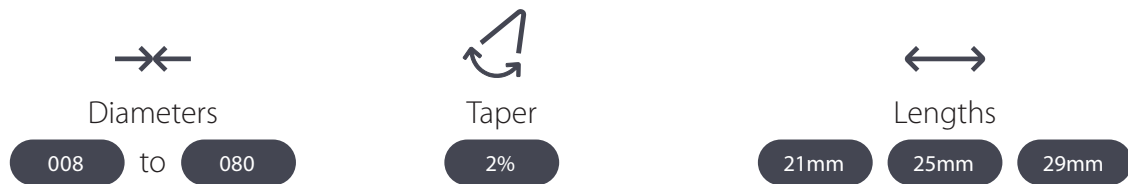
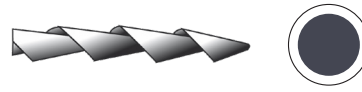

Length		008	010	015	020	025	030	035	040	045
L21	PrimeLine	20103010L	20103013L	20103016L	20103019L	20103022L	20103025L	20103028L	20103031L	20103034L
	New Ref.	60040788	60040789	60040790	60040791	60040792	60040793	60040794	60040795	60040796
L25	PrimeLine	20103011L	20103014L	20103017L	20103020L	20103023L	20103026L	20103029L	20103032L	20103035L
	New Ref.	60040804	60040805	60040806	60040807	60040808	60040809	60040810	60040811	60040812
L29	PrimeLine	20103012L	20103015L	20103018L	20103021L	20103024L	20103027L	20103030L	20103033L	20103036L
	New Ref.	60040821	60040822	60040823	60040834	60040825	60040826	60040827	60040828	60040829

Length		050	055	060	070	080	008/030	015/040	035/060	045/080
L21	PrimeLine	20103037L	20103040L	20103043L	20103046L	20103049L	/	20103001L	20103004L	20103007L
	New Ref.	60040797	60040798	60040799	60040800	60040801	/	60040802	60040803	/
L25	PrimeLine	20103038L	20103041L	20103044L	20103047L	20103050L	20103108L	20103002L	20103005L	20103008L
	New Ref.	60040813	60040814	60040815	60040816	60040817	60040818	60040819	60040820	/
L29	PrimeLine	20103039L	20103042L	20103025L	20103048L	20103051L	/	20103003L	20103006L	20103009L
	New Ref.	60040830	60040831	60040832	60040833	60040834	/	60040835	60040836	/

Flyer MM HandFiles
Switch PrimeLine

EN
80000564

MicroMega MM Tire-nerfs

NON-STERILE

- A historic and iconic manual endodontic instrument
- Used to remove dental pulp
- Non-sterile pack of 12 instruments

NEW

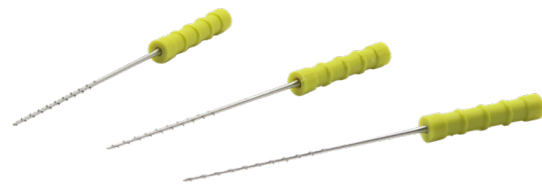

Diameters

015

to

050



Length

21mm

Reference	Description
60040577	P12 TIRE-NERFS N015 L21 MM M56
60040578	P12 TIRE-NERFS N020 L21 MM M56
60040579	P12 TIRE-NERFS N025 L21 MM M56
60040580	P12 TIRE-NERFS N030 L21 MM M56
60040581	P12 TIRE-NERFS N035 L21 MM M56
60040582	P12 TIRE-NERFS N040 L21 MM M56
60040583	P12 TIRE-NERFS N045 L21 MM M56
60040584	P12 TIRE-NERFS N050 L21 MM M56



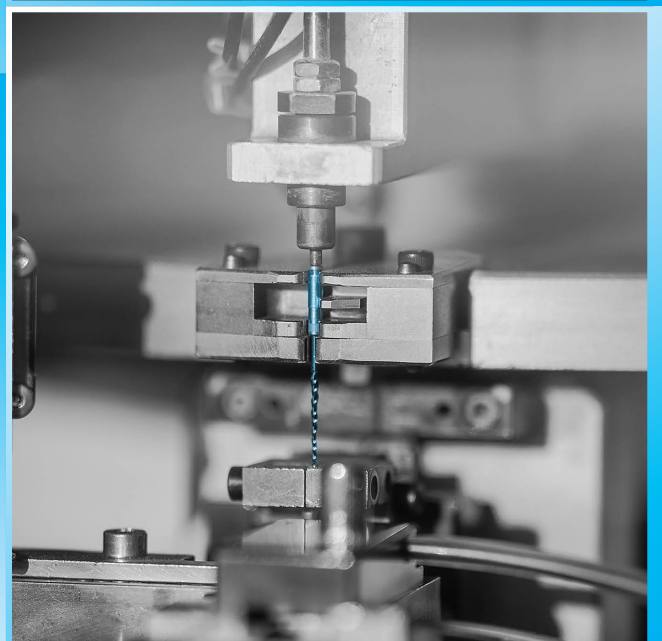
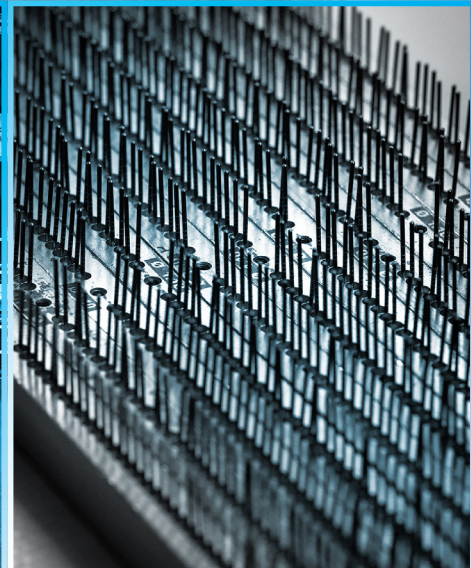
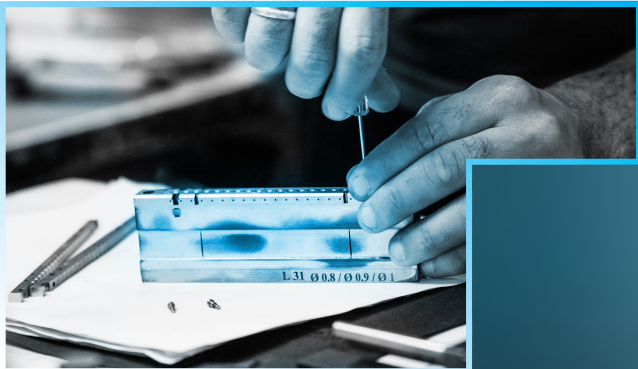
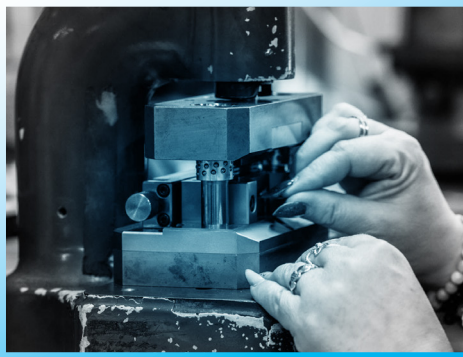
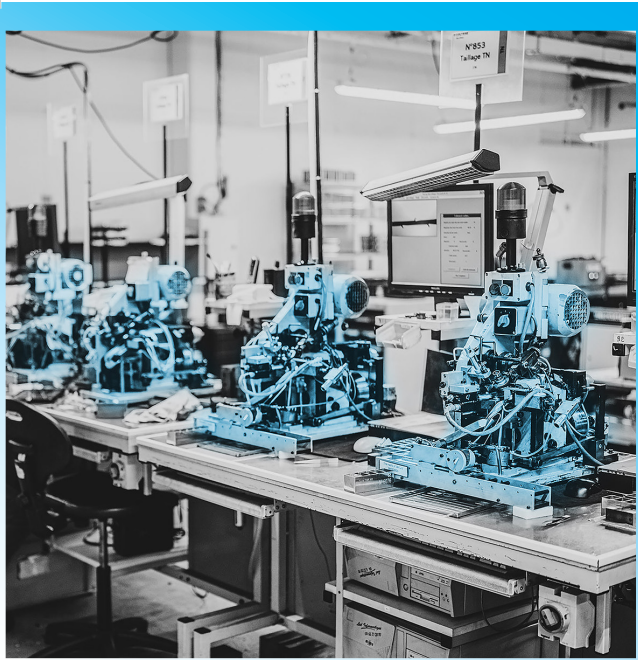

MECHANIZED FILES

MicroMega One Flare

Coronal flaring instrument

- Heat treated: improved fatigue resistance and increased flexibility
- Multiple use

Wire diameter
1.00mm

Diameter
25

Taper
9%

Length
17mm

Continuous rotation

Motor speed
250rpm to 400rpm

Maximum torque
3 N.cm

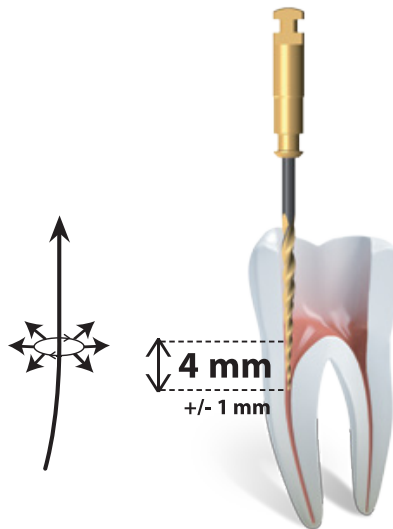
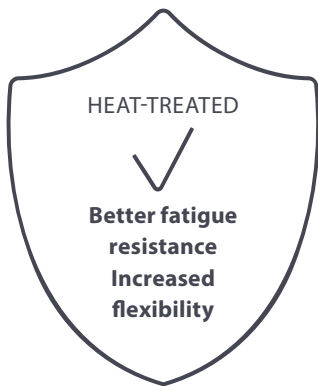

One Flare

5 instruments, pre-sterilized blister

Reference

B5 MicroMega One Flare n25 9% L17 20952201

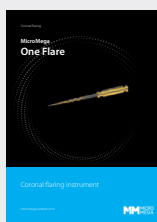

Flyer One Flare

EN

80000367

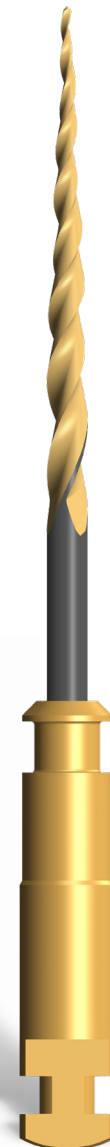

MECHANIZED FILES

MicroMega One G

The rotary glide path file

Wire diameter
0.60mm

Diameter
14

Taper
3%

Lengths

21mm 25mm 29mm

Continuous rotation

Motor speed
250rpm to 400rpm

Maximum torque
1.2 N.cm



- Variable pitch: limits the screwing effect
- Assymetric cross-section and cutting edges for better debris removal
- Non-cutting tip

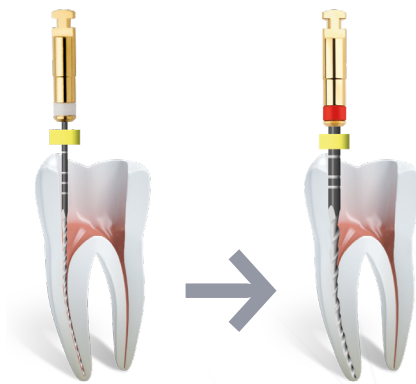

MicroMega One G

1 single instrument for glide path

Usual shaping sequence

One G

5 instruments, pre-sterilized blister

Reference

B5 MicroMega One G n14 3% L21	20948201
B5 MicroMega One G n14 3% L25	20948202
B5 MicroMega One G n14 3% L29	20948203

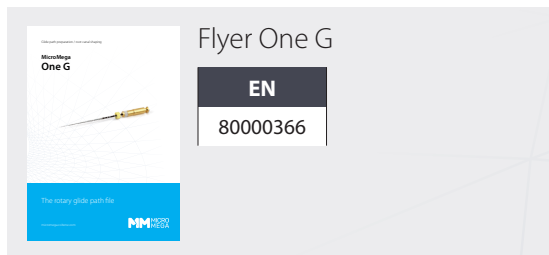

MECHANIZED FILES

MicroMega

GLIDEPATH

Creating a path through any obstacle

- Stress decrease and path preparation
- T.Wire : Flexibility
- Flat tip : Excellent guidance and preservation of the root canal anatomy
- Evolving cross section : High resistance and improvement of debris removal
- Available in continuous rotation and reciprocating motion



Wire diameter

0.80mm



Diameter

16



Lengths

21mm

25mm

31mm



Taper

3%





MicroMega One Glider

5 instruments, pre-sterilized blister

References



B5 MicroMega One Glider n16 3% L21 Ste	60036825
B5 MicroMega One Glider n16 3% L25 Ste	60036827
B5 MicroMega One Glider n16 3% L31 Ste	60036829

 Continuous rotation
 Motor Speed
 250-400 rpm
 Maximum torque
 1.2 N.cm



MicroMega RECI Glider

5 instruments, pre-sterilized blister

 Reciprocating angles
 170° / 60°
 Motor Speed
 400 rpm
 Maximum torque
 4 N.cm

References

B5 MicroMega RECI Glider n16 3% L21 Ste	60036826
B5 MicroMega RECI Glider n16 3% L25 Ste	60036828
B5 MicroMega RECI Glider n16 3% L31 Ste	60036830

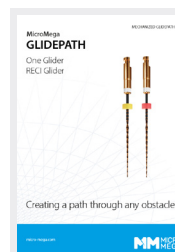

Flyer GLIDEPATH

EN	DE	ES
80000514	80000516	80000541

ROOT CANAL SHAPING

MicroMega 2Shape classic

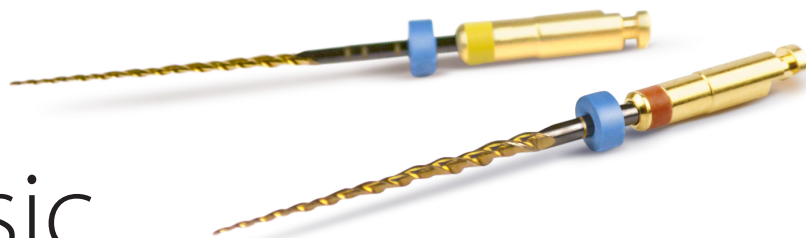

Sequence of 2 Shaping Files in continuous rotation

- Improved debris removal
- Reduced stress
- Increased fracture resistance



Wire diameter

1.20mm



Diameters

25

35

40



Tapers

4%

6%



Lengths

21mm

25mm

31mm



Continuous rotation



Motor speed

250rpm

to

400rpm



Maximum torque

2.5 N.cm

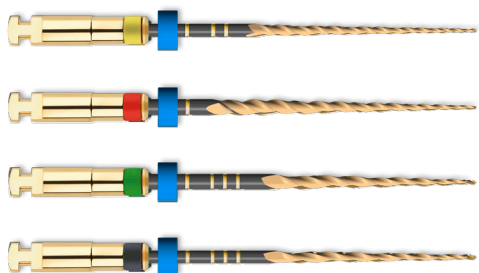

2Shape classic

5 instruments, pre-sterilized blister*

References	L21	L25	L31
TS1 2Shape N25 4%	20953001	20953011	20953021
TS2 2Shape N25 6%	20953002	20953012	20953022
F35 2Shape N35 6%	20953003	20953013	20953023
F40 2Shape N40 4%	20953004	20953014	20953024

2Shape classic

Guttapercha points*

References	60 pcs.
TS2 2Shape GP 25/.06 SB	60023609
F35 2Shape GP 35/.06 SB	60023610
F40 2Shape GP 40/.04 SB	60023611

2Shape classic

Paper points*

References	144 pcs.
TS2 2Shape PP 25/.06 CP	60023613
F35 2Shape PP 35/.06 CP	60023614
F40 2Shape PP 40/.04 CP	60023615

*Products sold by Coltene

ROOT CANAL SHAPING

MicroMega 2Shape mini

Minimally Invasive Preparation

- Preservation of pericervical dentin
- Elimination of minimal tooth structure
- Respect of root canal anatomy

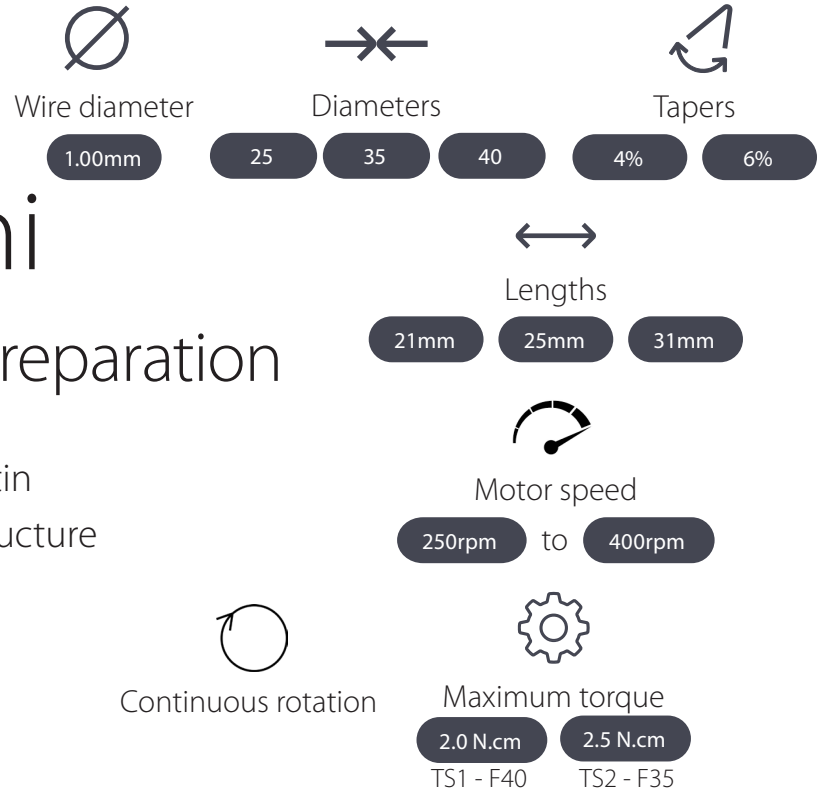

2Shape mini

5 instruments, pre-sterilized blister

References	L21	L25	L31
TS1 2Shape mini N25 4%	20953201	20953211	20953221
TS2 2Shape mini N25 6%	20953202	20953212	20953222
F35 2Shape mini N35 6%	20953203	20953213	20953223
F40 2Shape mini N40 4%	20953204	20953214	20953224

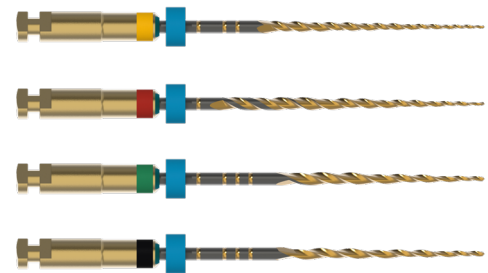

2Shape mini

Guttapercha points*

References	60 pcs.
2Shape mini GP 25/.04 SB	60031543
2Shape mini GP 25/.06 SB	60031545
2Shape mini GP 35/.06 SB	60031546
2Shape mini GP 40/.04 SB	60031544

2Shape mini

Paper points*

References	144 pcs.
2Shape mini PP 25/.04 CP	60031735
2Shape mini PP 25/.06 CP	60031738
2Shape mini PP 35/.06 CP	60031739
2Shape mini PP 40/.04 CP	60031737

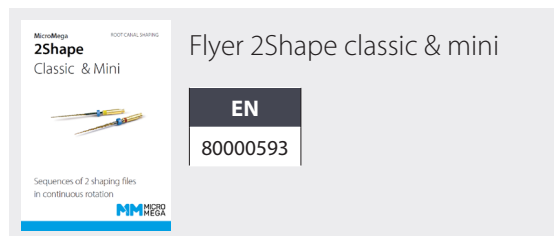

*Products sold by Coltene

ROOT CANAL SHAPING

MicroMega

One Curve classic

Single Shaping File in continuous rotation

- Resistant to cyclic fatigue
- Suitable for all types of root canals
- Optimized safety
- C-Wire heat treatment

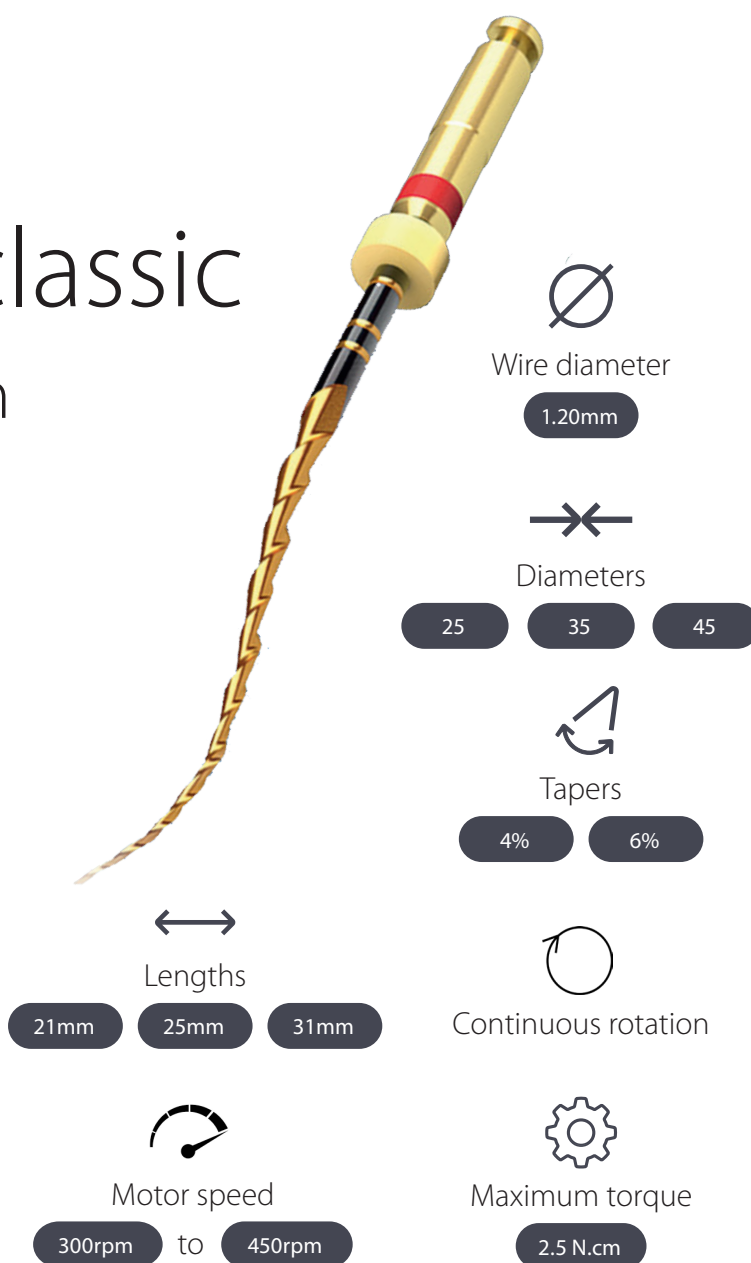
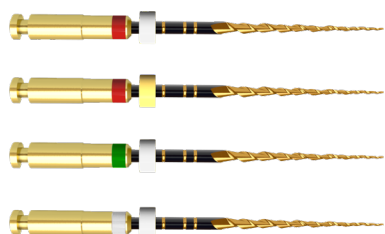
**One Curve classic**

5 instruments, pre-sterilized blister

References	L21	L25	L31
One Curve N25 4 %	20949431	20949441	20949451
One Curve N25 6 %	20949401	20949402	20949403
One Curve N35 4 %	20949432	20949442	20949452
One Curve N45 4 %	20949433	20949443	20949453
Assorted Sterile	20949435	20949445	20949455

One Curve classic

Guttapercha points*

References	60 pcs.
MicroMega OneCurve GP 25/.06 SB	60023612

One Curve classic

Paper points*

References	144 pcs.
MicroMega OneCurve PP 25/.06 CP	60023616

ROOT CANAL SHAPING

MicroMega

One Curve mini

Minimally Invasive Preparation

- Preservation of pericervical dentin
- Elimination of minimal tooth structure
- Respect of root canal anatomy

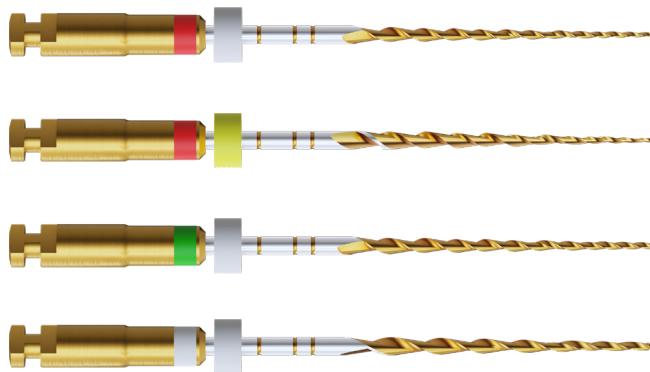

Wire diameter

1.00mm



Diameters

25

35

45



Tapers

4%

6%



Lengths

21mm

25mm

31mm



Continuous rotation



Motor speed

300rpm

à

450rpm



Maximum torque

2.5 N.cm

MicroMega One Curve mini

5 instruments, pre-sterilized blister

References	L21	L25	L31
One Curve mini N25 4%	60030017	60030021	60030025
One Curve mini N25 6%	60030018	60030022	60030026
One Curve mini N35 4%	60030019	60030023	60030027
One Curve mini N45 4%	60030020	60030024	60030028
Assorted Sterile	60030033	60030034	60030035

MicroMega One Curve mini

Guttapercha points*

References	60 pcs.
One Curve mini GP 25/.04 SB	60031547
One Curve mini GP 25/.06 SB	60031550
One Curve mini GP 35/.04 SB	60031548
One Curve mini GP 45/.04 SB	60037029

MicroMega One Curve mini

Paper points*

References	144 pcs.
One Curve mini PP 25/.04 CP	60031741
One Curve mini PP 25/.06 CP	60031745
One Curve mini PP 35/.04 CP	60031743
One Curve mini PP 45/.04 CP	60031744

Single File: simplicity driving performance

MM MICRO MEGA

Flyer One Curve mini

EN	DE
80000302	80000303
ES	IT
80000304	80000305

*Products sold by Coltene

ROOT CANAL SHAPING

MicroMega MM TAPER

Shape with Confidence,
Perform with Precision

- 1 opener, 2 shaping files and 5 finishers
- S.Wire heat treatment: flexibility and resistance to cyclic fatigue



Diameters

17 à 50



Tapers

02 à 09



Lengths

19mm

21mm

25mm

31mm

SX

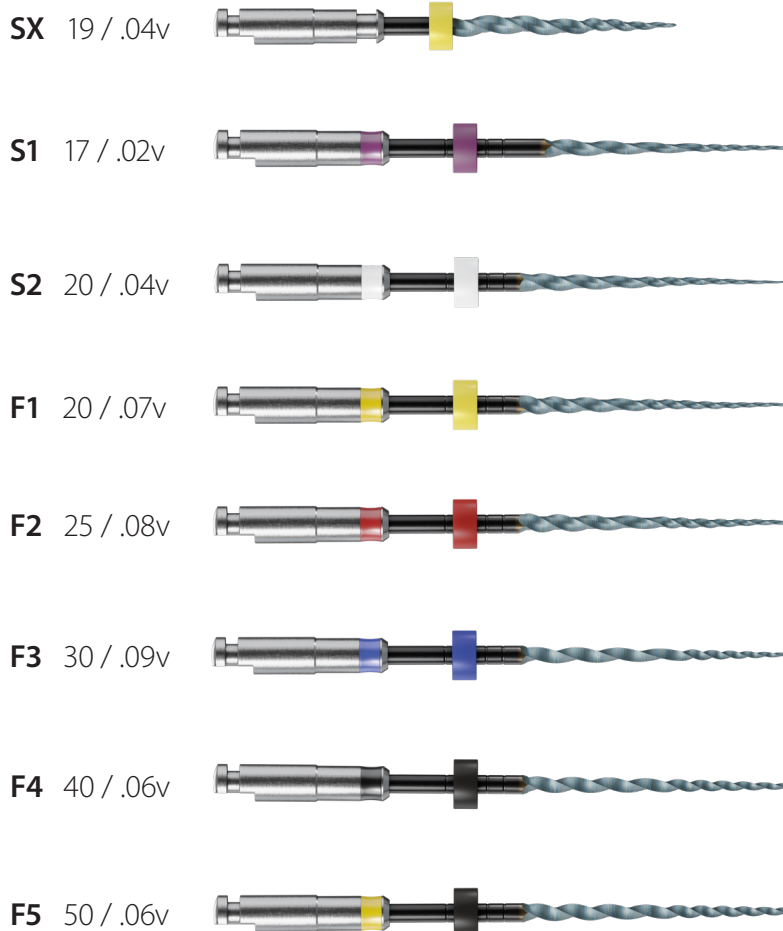



Continuous rotation



Motor speed

250 - 350 rpm



Maximum torque

5.1 N.cm

SX - S1

1.5 N.cm

S2 - F1

3.1 N.cm

F2 - F3 - F4 - F5

MM TAPER

References

B6 MM Taper SX 19 /V04 L19	60040593
B6 MM Taper S1 17/V02 L21	60040594
B6 MM Taper S1 17/V02 L25	60040595
B6 MM Taper S1 17/V02 L31	60040596
B6 MM Taper S2 20/V04 L21	60040597
B6 MM Taper S2 20/V04 L25	60040598
B6 MM Taper S2 20/V04 L31	60040599
B6 MM Taper F1 20/V07 L21	60040600
B6 MM Taper F1 20/V07 L25	60040601
B6 MM Taper F1 20/V07 L31	60040602
B6 MM Taper F2 25/V08 L21	60040603
B6 MM Taper F2 25/V08 L25	60040604
B6 MM Taper F2 25/V08 L31	60040605

References

B6 MM Taper F3 30/V09 L21	60040606
B6 MM Taper F3 30/V09 L25	60040607
B6 MM Taper F3 30/V09 L31	60040608
B6 MM Taper F4 40/V06 L21	60040609
B6 MM Taper F4 40/V06 L25	60040610
B6 MM Taper F4 40/V06 L31	60040611
B6 MM Taper F5 50/V06 L21	60040612
B6 MM Taper F5 50/V06 L25	60040613
B6 MM Taper F5 50/V06 L31	60040614
B6 ASST MM Taper L21	60040615
B6 ASST MM Taper L25	60040616
B6 ASST MM Taper L31	60040617



ROOT CANAL SHAPING

MicroMega One RECI

Exploring new directions

- Cutting efficiency: patented variable, asymmetrical cross-section
- Safety: cyclic fatigue resistance
- Flexibility: respect of the root canal anatomy thanks to C.Wire heat treatment

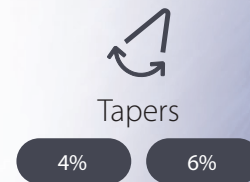
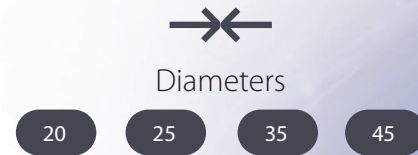
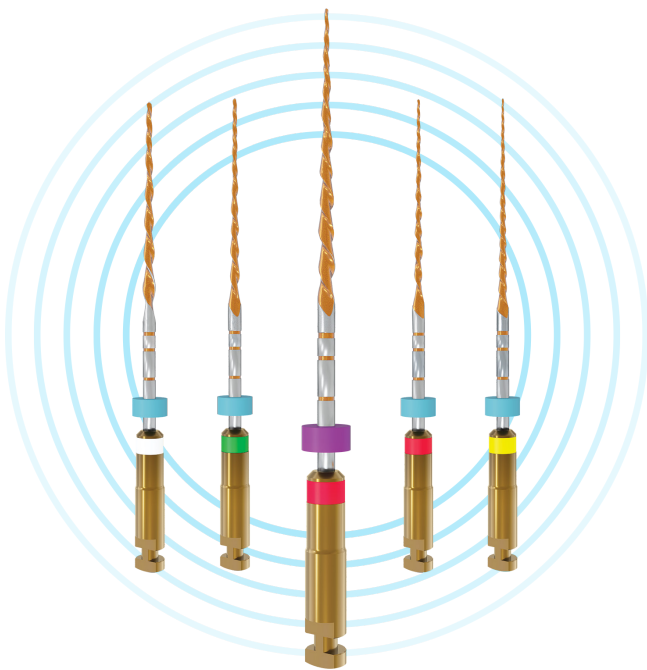

MicroMega One RECI

5 instruments, pre-sterilized blister

References	L21	L25	L31
B5 MicroMega One RECI n20 4% Sterile, 5 pcs	60029878	60029883	60029888
B5 MicroMega One RECI n25 4% Sterile, 5 pcs	60029879	60029884	60029889
B5 MicroMega One RECI n25 6% Sterile, 5 pcs	60029880	60029885	60029890
B5 MicroMega One RECI n35 4% Sterile, 5 pcs	60029881	60029886	60029891
B5 MicroMega One RECI n45 4% Sterile, 5 pcs	60029882	60029887	60029892
B5 One RECI Assorted Sterile	60029898	60029899	60029900

MicroMega One RECI

Guttapercha points*



References	60 pcs.
One RECI GP 20/.04 SB	60031551
One RECI GP 25/.04 SB	60031552
One RECI GP 25/.06 SB	60031679
One RECI GP 35/.04 SB	60031553
One RECI GP 45/.04 SB	60037026

MicroMega One RECI

Paper points*



References	144 pcs.
One RECI PP 20/ .04 CP	60031746
One RECI PP 25/ .04 CP	60031747
One RECI PP 25/ .06 CP	60031750
One RECI PP 35/ .04 CP	60031748
One RECI PP 45/ .04 CP	60031749

Flyer One RECI

EN	DE	ES	IT
80000213	80000214	80000215	80000216
FI	PL	SV	
80000252	80000381	80000253	

*Products sold by Coltene

ROOT CANAL SHAPING

MicroMega

HERO 642

Shaping files sequence

- Continuous rotation sequence
- Crown-down technique

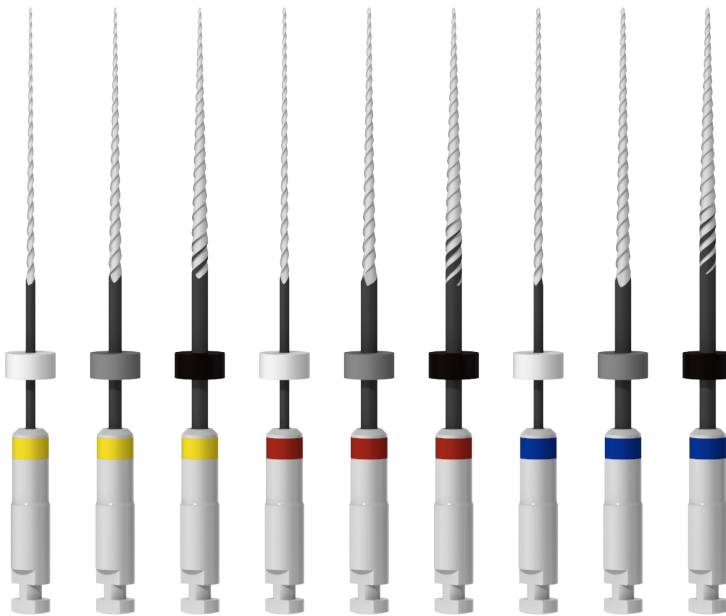

Wire diameters

0.60mm

0.80mm

1.00mm



Diameter

20

to

30



Tapers

2%

4%

6%



Lengths

21mm

25mm



Continuous rotation



Motor speed

300rpm

to

600rpm

HERO 642

6 instruments, non sterile pack

References	020	025	030
P6 HERO 642 L21 2% Classics	20136114	20136115	20136116
P6 HERO 642 L21 4% Classics	20136120	20136121	20136122
P6 HERO 642 L21 6% Classics	20136110	20136111	20136112
P6 HERO 642 L25 2% Classics	20136101	20136102	20136103
P6 HERO 642 L25 4% Classics	20136107	20136108	20136109
P6 HERO 642 L25 6% Classics	20136132	20136133	20136134

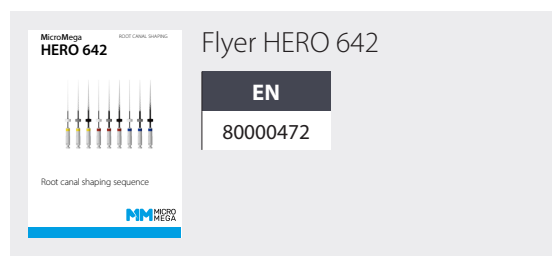

ROOT CANAL SHAPING

MicroMega

HERO Shaper

Shaping files sequence
in continuous rotation



Continuous rotation



Tapers

4%

6%



Lengths

21mm

25mm



Wire diameter

1.20mm



Diameter

20

à

30



Motor speed

300rpm

à

600rpm

HERO Shaper Classics

6 instruments, non sterile pack

References	L21	L25
P6 HERO Shaper n20 4% Classics	20136417	20136404
P6 HERO Shaper n25 4% Classics	20136418	20136405
P6 HERO Shaper n30 4% Classics	20136419	20136406
P6 HERO Shaper n35 4% Classics	20136423	20136420
P6 HERO Shaper n40 4% Classics	20136424	20136421
P6 HERO Shaper n45 4% Classics	20136425	20136422
P6 HERO Shaper n20 6% Classics	20136401	20136410
P6 HERO Shaper n25 6% Classics	20136402	20136411
P6 HERO Shaper n30 6% Classics	20136403	20136412

HERO Shaper for specific root canals

6 instruments, non sterile pack

References	
P2 HERO Shaper EASY CANALS	20136413
P3 HERO Shaper CANALS OF MEDIUM DIFFICULTY	20136414
P4 HERO Shaper DIFFICULT CANALS	20136415



OBTURATION



MicroMega Revo Condensor

The perfect tool for thermomechanical condensation

- Safe, optimum transport of gutta percha
- Flexible and highly reliable
- Its conical shape provides additional safety, reducing the risk of breakage

Revo Condensor

4 instruments non sterile pack

References

P4 Revo Condensor NITI N30 L25 4%	20137701
P4 Revo Condensor NITI N30 L29 4%	20137702



Wire diameter

1.00mm



Diameter

30



Tapers

4%



Lengths

25mm

29mm



Continuous rotation



Motor Speed

10000rpm

to

15000rpm

RETREATMENT

MicroMega REMOVER

The essential part
of your retreatment

Wire diameter
1.00mm

Diameter
30

Tapers
7%

Lengths
19mm 23mm

Continuous rotation

Motor Speed
400rpm to 800rpm

Maximum torque
2.5 N.cm

- A file for removing root canal filling material
- Respects of the root canal anatomy
- Inactive tip

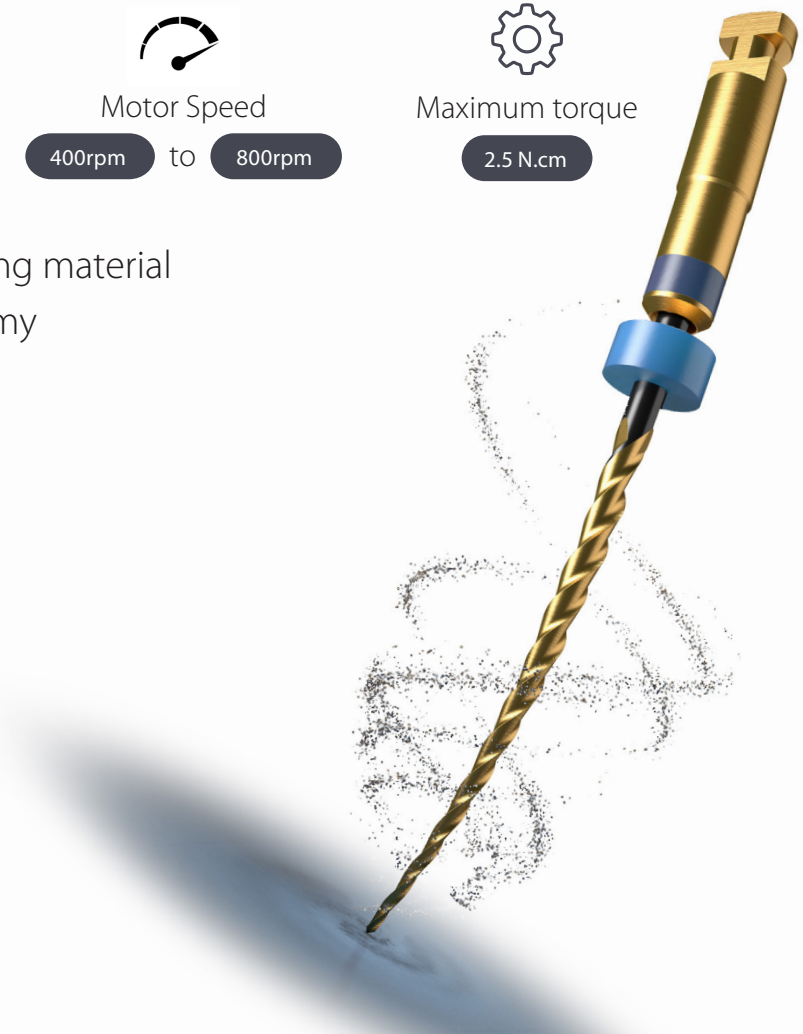
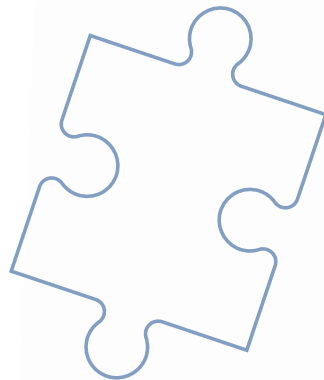

MicroMega REMOVER

5 instruments, pre-sterilized blister

References	L19	L23
B5 MicroMega Remover n30 7% Classics, 5 pcs	20952301	20952311

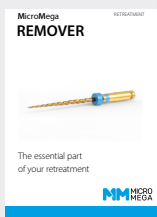

The essential part
of your retreatment



Flyer REMOVER

EN	DE	ES
60301861	60302861	60303861
IT	PT	
60304861	80000186	



CORDLESS ENDO MOTOR

MicroMega MM 4000

Precision you can trust,
performance you can feel

- Cordless, for a total freedom of movement
- Intuitive and simplified user interface
- Insulated contra-angle with mini head and slim neck, easy and practical access with clear visibility
- Integrated apex locator, designed to ensure both effective and safe canal preparation

Two new modes:

Ledge Bypass Mode: Assists in bypassing a ledge.

Block Bypass Mode: Helps navigate a blocked canal or a fractured instrument.





Motor Speed

100-3000 rpm



Torque

0.4-5.0 Ncm



Gear ratio

6:1 Rotation to 360°



Reciprocating angles

5° to 400° (adjustable)



MM 4000

References

MM 4000	65003080
---------	----------

Spare parts

Motor Handpiece MM 4000	65003092
Charging base MM 4000	65003093
MM 4000 Box	65003094
Universal AC-Adapter MM 4000	65003121
Black Ring MM 4000	65003122
Battery MM 4000	65003123
Spray Nozzle MM 4000	65003124
File holder MM 4000	65003125
Contra angle MM 4000	65003126
Measuring wire MM 4000	65003127
Lip clip MM 4000	65003128
"O"-ring MM 4000	65003129
Disposable sleeve MM 4000	65003130
Touch probe MM 4000	65003131



IRRIGATION AND RINSING

CanalPro

For irrigation/debridement of root canals during and after instrumentation.
Available in 3% and 6% formula.



CanalPro NaOCl 3%

CanalPro NaOCl 3%	65002866
CanalPro NaOCl 3% 500 ml, square bottle	

CanalPro NaOCl 6%

CanalPro NaOCl 6%	65002867
CanalPro NaOCl 6% 500 ml, square bottle	

Additional range available from Coltene:

CanalPro Color Syringes 5 ml

CanalPro Color Syringes 5 ml	
● 50 × Color Syringes 5 ml	60019321
● 50 × Color Syringes 5 ml	60019322
● 50 × Color Syringes 5 ml	60019323
● 50 × Color Syringes 5 ml	60019324

CanalPro Color Syringes 10 ml

CanalPro Color Syringes 10 ml	
● 50 × Color Syringes 10 ml	60011173
● 50 × Color Syringes 10 ml	60011174
● 50 × Color Syringes 10 ml	60011175
● 50 × Color Syringes 10 ml	60011176

CanalPro SyringeFill Wall mounted

CanalPro SyringeFill Holder	60019667
1 × Bottle holder for wall mounting 3 × CanalPro SyringeFill Cap	



CanalPro SyringeFill Station

CanalPro SyringeFill Station	60019661
1 × Bottle holder incl. base 3 × CanalPro SyringeFill Cap	



OBTURATION

MicroMega MM-MTA

Successful repair of iatrogenic accidents while reducing the associated pathological complications.

MicroMega MM-MTA

20604002

MM-MTA

MicroMega MM-Paste

Calcium hydroxide paste designed for temporary canal fillings and pulp capping

MicroMega MM-Paste

20600104

- 1 × 2.2 g MM-Paste in a syringe.
- 1 × Disposable, single-use tips.
- 1 × One rotator ring to control the direction of the tip.

MicroMega MM-Seal

MM-Seal is a high quality epoxy cement for permanent root canal filling.

MicroMega MM-Seal

20600106

- 1 × 13.5 g Dual syringe (base 9 g, catalyst 4.5 g)
- 1 × Mixing plate
- 1 × Spatula

OBTURATION

MicroMega

MM Bioceramic Sealer

MM Bioceramic Sealer is used for root canal obturation, in combination with a gutta-percha point, applied as a thin layer that offers excellent flow and a perfect seal.

- Ready to use
- Bioactive
- High alkalinity (pH 12)
- Excellent flowability
- High radiopacity
- Does not stain
- Suitable for both cold and hot techniques

Bioceramic root canal sealer ready to use



MicroMega MM Bioceramic Sealer 65003075

- 1 × 2 g Bioceramic Sealer syringe.
- 20 × Application tips.
- 1 × Instruction card.

Technical Sheet
MM Bioceramic

EN	FR
80000602	80000601

OBTURATION

MicroMega

MM Bioceramic Putty

MM Bioceramic Putty is a denser material indicated for root canal repairs (perforations, resorption, pulp capping) or retrograde fillings in endodontic surgery.

- Ready to use
- Bioactive
- High alkalinity (pH 12)
- High radiopacity

Bioceramic reparative material ready to use



MicroMega MM Bioceramic Putty

65003076

- 1 × 0.5 g Bioceramic Putty syringe.
- 1 × Instruction card.

MicroMega
MM Bioceramic
Sealer and Putty

Bioceramics:
Elevating Clinical Standards

Flyer MM Bioceramic

EN	FR
80000582	80000581

Additional products / services

MicroMega training material

MicroMega

MM-3D-Tooth

As real as a tooth, ideal for training

The 3D-Tooth is the perfect replica of a natural mandibular molar, 3D printed using X-ray microtomography.

- Feeling comparable to clinical practice
- Adapted to the different manual or mechanized endodontic systems used
- Perfect visualization of the progression of the instruments in the root canals
- Assessment of the quality of canal shaping, adaptation of the master cone and the final obturation

MicroMega 3D-Tooth

Bag of 25

60036275

MicroMega

Endobloc

Endo bloc for training with J-Shape



- Diameter 15
- Taper .02

MicroMega Endobloc

Bag of 100

50016409

MicroMega

Training Kit

Training Kit with One G

Training Kit 2Shape Classic	51400117
Training Kit 2Shape Mini	60033864
Training Kit One Curve Classic	51400122
Training Kit One Curve Mini	60030039
Training Kit One RECI	60029904

Training Kit with new Gliders

Training Kit 2Shape Classic One Glider	60041066
Training Kit 2Shape Mini One Glider	60041065
Training Kit One Curve Classic One Glider	60041067
Training Kit One Curve Mini One Glider	60041068
Training Kit One RECI RECI Glider	60041069



Training Kit Customizable

60043037

Customizable training kit (file or sequence to be ordered separately)

Regulatory information

K-Files, K-Reamers, H-Files

CE 0459 | Medical class I according to regulation (UE) 2017/745 EEC.

Notified body: GMED.

Legal manufacturer: Micro-Mega SA.

MM K-Files, MM H-Files

Medical device class I according to regulation (UE) 2017/745.

Legal manufacturer: Micro-Mega SA.

PrimeLine MM K-Files, MM H-Files

Medical device class I according to regulation (UE) 2017/745.

Legal manufacturer: Micro-Mega SA.

MicroMega Nerve Broaches

CE 0459 | Medical class I according to directive 93/42/EEC.

Notified body: GMED.

Legal manufacturer: Micro-Mega SA.

One Flare

CE 0459 | Medical class IIa in according to Directive 93/42/EEC.

Notified body: GMED.

Legal manufacturer: Micro-Mega SA.

One G

CE 0459 | Medical class IIa in according to Directive 93/42/EEC.

Notified body: GMED.

Legal manufacturer: Micro-Mega SA.

MicroMega One Glider | MicroMega RECI Glider

CE 0459 | Medical class IIa according to Directive 93/42/EEC.

Notified body: GMED

Legal manufacturer: Micro-Mega SA.

2Shape / 2Shape Mini

CE 0459 | Medical class IIa according to Directive 93/42/EEC.

Notified body: GMED.

Legal manufacturer: Micro-Mega SA.

One Curve / MicroMega One Curve mini

CE 0459 | Medical class IIa according to Directive 93/42/EEC.

Notified body: GMED.

Legal manufacturer: Micro-Mega SA.

MM TAPER

CE 0459 | Medical device class IIa according to Directive 93/42/EEC.

Notified body: GMED.

Legal manufacturer: Micro-Mega SA.

MicroMega One RECI

CE 0459 | Medical class IIa according to Directive 93/42/EEC.

Notified body: GMED.

Legal manufacturer: Micro-Mega SA.

HERO 642

CE 0459 | Medical class IIa according to Directive 93/42/EEC.

Notified body: GMED.

Legal manufacturer: Micro-Mega SA.

HeroShaper

CE 0459. Medical class IIa according to Directive 93/42/EEC.

Notified body: GMED

Legal manufacturer: Micro-Mega SA.

Revo Condensor

CE 0459 | Medical device class IIa according to directive 93/42/EEC.

Notified body: GMED

Legal manufacturer: Micro-Mega SA.

MicroMega Remover

CE 0459 | Medical device class IIa according to directive 93/42/EEC.

Notified body: GMED.

Legal manufacturer: Micro-Mega SA.

MM4000

CE 0197 | Medical device class IIa according to Regulation MDR 2017/745. Notified body: TÜV Rheinland.

Legal manufacturer: Guilin Woodpecker (China).

CanalPro NaOCl 3% et 6%

CE 0537 | Medical class IIa according to directive 93/42/EEC.

Certification body: Eurofins Expert Services.

Legal manufacturer: Magnum Dental OÜ (Estonia).

MM-MTA

CE 0482 | Medical class IIa according to directive 93/42/EEC.

Certification body: Med/Cert.

Legal manufacturer: S & C Polymer Silicon and Composite Spezialitäten GmbH (Germany).

MM-SEAL

CE 1639 | Medical class IIa according to directive 93/42/EEC.

Certification body: SGS Belgium NV.

Legal manufacturer: META-BIOMED (South Korea).

MM-PASTE

CE 1639 | Medical class IIa according to directive 93/42/EEC.

Notified body: SGS Belgium NV.

Legal manufacturer: META-BIOMED (South Korea).

MM Bioceramic Putty, MM Bioceramic Sealer

CE 2460 | Medical class IIa according to Regulation MDR 2017/745.

Notified body: DNV (Det Norske Veritas)

Legal manufacturer: ANGELUS INDÚSTRIA DE PRODUTOS ODONTOLÓGICOS S/A (Brasil).

Medical device for dental care, reserved for healthcare professionals, not reimbursed by Social Security. See product labeling and, where applicable, instructions.

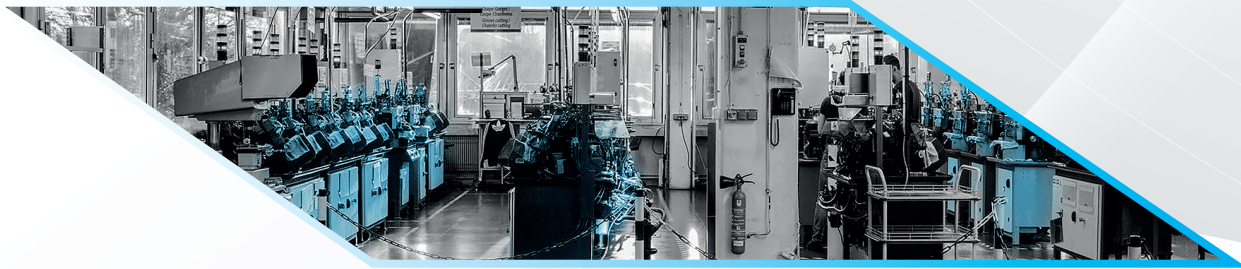

Scan to visit our website :



micro-mega.com

Follow us on socials :



[@micromega_international](https://www.instagram.com/micromega_international)



[Micro-Mega SA](https://www.linkedin.com/company/micro-mega-sa)



[Micro-Mega International](https://www.facebook.com/micro-mega-international)

Information products

branded.products.mm@coltene.com

Customer service

mm.sales@coltene.com

Marketing service

mm_marketing@coltene.com

Customer Service Micro-Mega

12 rue du Tunnel

25000 Besançon France

+33 3 81 54 42 36

customer.service@micro-mega.com

80000554-B 05.26

COLTENEGROUP